

Varenummer: 3901030030200  
 Beskrivelse: Snekkegear med fri indgangsaksel  
 VF 30A-30-HS

## Mål

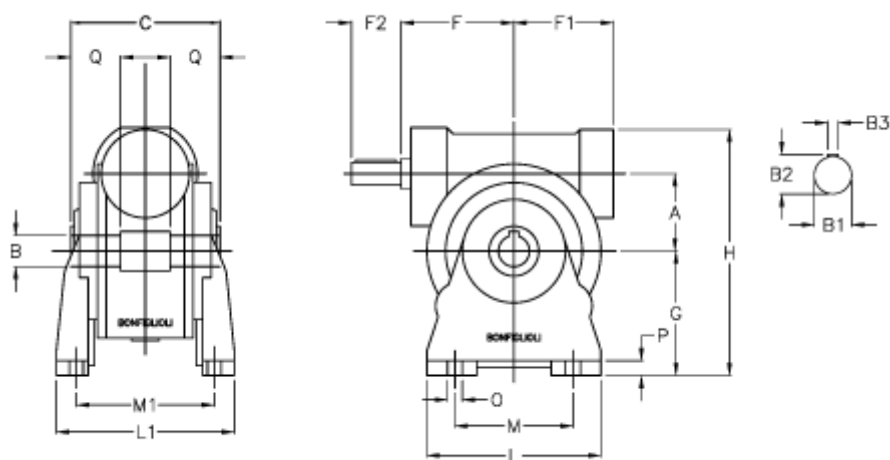

a	= 30.0	F1 = 46	P = 8
B	= 14	g = 55	Q = 20.5
B1 E7	= 9	H = 105	
B2	= 10.2	L = 80	
B3 H9	= 3	L1 = 80	
Betegnelse	= VF 30A-xx-HS	m = 50	
C	= 55	M1 = 66.0	
F	= 50.0	O = 6.5	